

# KENT VORTEX SS

WET & DRY

## VACUUM CLEANER (10L)

**KENT**  
Cyclonic  
Vacuum Cleaners  
HOUSE of PURITY

### Instruction Manual

**KENT**  
Cyclonic  
Vacuum Cleaners  
HOUSE of PURITY



WET & DRY  
FUNCTION



BLOWER  
FUNCTION



HIGH  
SUCTION



Imported & Marketed by:  
**KENT RO SYSTEMS LTD.**  
E-6, Sector-59, Noida, U.P.-201 309, India.

For customer complaints,  
contact our Customer Care Officer at:  
E-6, Sector-59, Noida, U.P.-201 309, India.  
Call: 92-789-12345  
E-mail: [service@kent.co.in](mailto:service@kent.co.in) or visit us at [www.kent.co.in](http://www.kent.co.in)

# Welcome to KENT



Dear Customer,

At the outset, allow us to thank you for your trust in KENT Vortex SS Wet & Dry Vacuum Cleaner. At KENT, we take pride in our reputation for product quality and industry proven performance. We are certain that your decision to own KENT Vortex SS Wet & Dry Vacuum Cleaner will go a long way towards keeping you and your family in good health. We are confident that you will be more than satisfied with its performance and it will serve your need for a safer and cleaner living, without any compromise.

This guide would help you in getting the best out of your KENT Vortex SS Wet & Dry Vacuum Cleaner. Please go through the booklet to familiarize yourself with its proper operation and maintenance. So that you can look forward to years of trouble-free service. To ensure that the warranty of your KENT Vortex SS Wet & Dry Vacuum Cleaner is effective, it is important that you fill up the enclosed warranty card and mail it to us within 15 days of purchase.

In case you require any further information, please contact your nearest KENT dealer or branch.

Happy Cleaning,

**KENT RO Systems Ltd.**

## Table of Contents

1.	Introduction .....	1
2.	Features of KENT Vortex SS Wet & Dry Vacuum Cleaner .....	1
3.	Know Your Product .....	1
4.	Items in the Box .....	2
5.	Assembling your KENT Vortex SS Wet & Dry Vacuum Cleaner.....	2
6.	Using the Appliance .....	3
7.	Important Instructions .....	4
8.	Cleaning and Maintenance.....	5
9.	Important Safety Instructions .....	6
10.	Troubleshooting .....	7
11.	Technical Specifications.....	7

## Introduction

We, at KENT have always believed that a clean and healthy life is the right of every individual. This ethos made us embark on the journey to develop innovative solutions for purifying water, fruits & vegetables and air. With the use of an innovative technology and supported by a competent service network, we have been able to create a brand, which has become synonymous with well-being and health.

Continuing with the tradition, we now present the KENT Vortex SS Wet & Dry Vacuum Cleaner, with state-of-the-art technology & feature to pick wet spills and dry dirt to provide clean, dust-free and spotless surroundings.

KENT Vortex SS Wet & Dry Vacuum Cleaners, do not use filtration bags, unlike traditional vacuum cleaners available in the market. The dust and wet spills are collected in a Stainless Steel body with a 10 L capacity for easy disposal of waste.

## Features of KENT Vortex SS Wet & Dry Vacuum Cleaner

1. Picks up dry dust and wet spills from the surface.
2. Blower function to remove deep embedded dust.
3. It has Stainless Steel body with 10 L capacity.
4. High efficiency motor with a strong suction force for efficient cleaning.
5. Rubberised wheel for ease of movement.
6. Light weight & low noise.

## Know Your Product

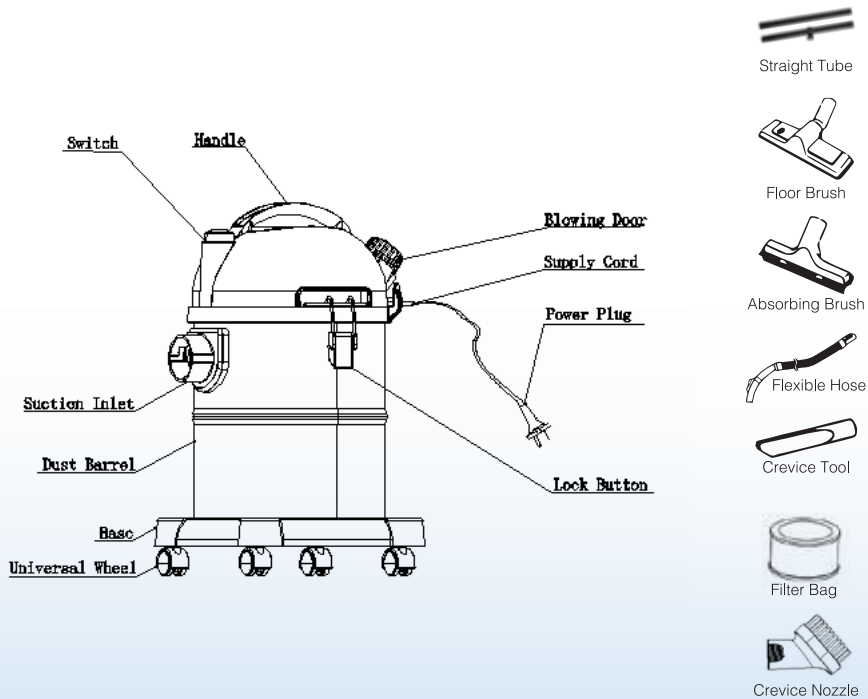

## Items in the Box

1. KENT Vortex SS Wet & Dry Vacuum Cleaner	:	1 N
2. Flexible Hose	:	1 N
3. Straight Tube	:	2 N
4. Crevice Tool	:	1 N
5. Floor Brush	:	1 N
6. Absorbing Brush	:	1 N
7. Filter Bag	:	1 N
8. Crevice Nozzle	:	1 N
9. User Manual	:	1 N

## Assembling Your KENT Vortex SS Wet & Dry Vacuum Cleaner

1. Unpack the unit completely and remove any stickers that can prevent unit operation.
2. Check the unit for damages. Do not use it in case of any damages.
3. Before switching on the unit, make sure that your home mains voltage corresponds to the unit operating voltage.

## Attaching/ Detaching the Flexible Hose

### a. Attaching

1. Attach the flexible hose in the air intake duct on the appliance, press until it clicks into position.
2. The grooves on the flexible hose cap must be aligned properly.

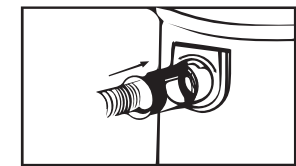

Attaching

### b. Detaching

1. To detach the flexible hose from the air intake duct, rotate counter-clockwise and pull out.

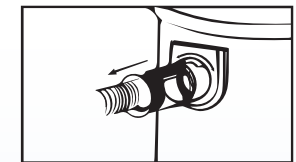

Detaching

## Attaching/ Detaching Straight Tubes

### Attaching

- Attach the straight tube to the handle by pushing it in the direction as shown in the figure.

### Detaching

- To detach it, pull in the reverse direction of the arrow.



Straight Tubes

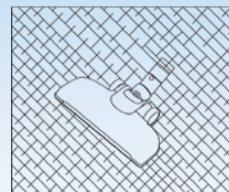

Carpet

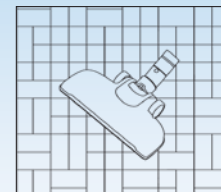

Hard/ Wooden Floor



Wet Floor

## Attaching/ Detaching Absorbing Brush & Floor Brush

### Attaching

- Attach the Absorbing brush/Floor brush to the straight tubes in the direction of the arrow.

### Detaching

- You can detach the straight tubes from the Absorbing brush/Floor brush by pulling it.

Absorbing Brush



Floor Brush



## Using the Appliance

- Connect all the accessories.
- To use the appliance, plug the appliance to main power supply.
- Press on/off button to switch on your appliance.

## Use of Accessories

### Crevice Tool

- Your KENT Vortex SS Wet & Dry Vacuum Cleaner comes with crevice tools which are ideal for cleaning surfaces, which are otherwise difficult to clean, such as radiators, couch corners, under the couch and in-between cushions.



Crevice tool

### Floor Brush

- Ideal for the daily cleaning of carpets and hard/ wooden floors.

### Absorbing Brush

- An ideal tool when it comes to wet cleaning. Use flat nozzle crevice tool or water brush for cleaning.

### Crevice Nozzle

- Ideal for the daily cleaning of sofa, bed, topside, hard surface, curtains, TV, fridge and fan.



Crevice Nozzle

## Important Instructions

1. Do not operate the vacuum cleaner too close to heaters, radiators, cigarette butts, etc.
2. Do not plug or unplug the device with wet hands.
3. Before using the vacuum cleaner, remove large or sharp objects from the floor in order to prevent damage of the HEPA filter.
4. To unplug, do not pull the electrical cord, instead pull out the plug.



**Note:** If the suction pipe or straight tube is blocked, switch-off the vacuum cleaner at once. Unplug the appliance and clear the blockage. Once done, start the vacuum cleaner again.

## Cleaning and Maintenance

1. Switch-off and unplug the appliance before cleaning it.

**Note:** Never use gasoline, solvent, abrasive cleaning agents, metal objects or hard brushes to clean the appliance.

2. Cleaning Filters: Your KENT Vortex SS Wet & Dry Vacuum Cleaner comes with a washable foam and HEPA filters for effective dry and wet cleaning.

### Removing and cleaning washable foam and HEPA filter

1. Remove the upper body assemble by opening the lock attached to the main body.

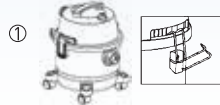

2. Gently pull the upper body to detach it from the main body.



3. Gently remove the filter cartridge by rotating and pulling it out.



4. Detach the HEPA filter from the outer foam filter by pulling it out.

5. Rinse filters in lukewarm water and dry them completely.

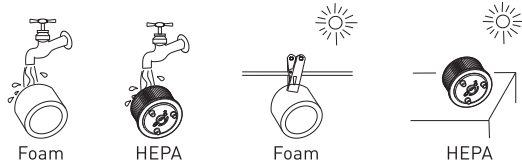

6. Once the filters are dry, put them back in reverse order.

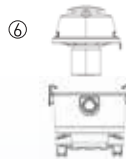

7. Filters should be cleaned at least twice in a year, or when it becomes visibly soiled.
8. Always operate the appliance with filters installed.
9. Always unplug the appliance before cleaning the filters.
10. Do not use washing machine to rinse filters.
11. Do not use a hair dryer to dry it.

## Storage

- If you do not intend to use the appliance for a long time, store it carefully.
- Plug out the appliance when not in use.
- Keep the appliance out of the reach of children.



## Warranty Card

**Product:** KENT Vortex SS Wet & Dry Vacuum Cleaner

**Product Code:** 116159

**Serial No.:**..... **Dealer Stamp:**.....

### CUSTOMER DETAILS:

Customer's Name: .....

Customer's Address: .....

Customer Phone No.: .....

### WARRANTY DETAILS:

Invoice Date: ..... Invoice No.: .....

**SERVICE**

To request for service 24x7, download KENT Service App by scanning the QR code or by giving a missed call: 9212252852

To speak to customer care executive call: 92-789-12345

Imported and Marketed by:

**KENT RO SYSTEMS LTD.**

E-6, Sector-59, Noida, U.P.-201 309, India.

E-mail: [service@kent.co.in](mailto:service@kent.co.in) | Website: [www.kent.co.in](http://www.kent.co.in)

Customer Care: 92-789-12345

## Terms & Conditions of Warranty

KENT warrants all new products manufactured by it to be free from defects in material and workmanship under normal usage and service from the date of purchase as under:

1. The Warranty period commences from the date of purchase by the first end-user. During this Warranty period of one year, KENT or its Authorized Service Provider (ASP) will replace or repair any part of KENT Vacuum Cleaner, that in the opinion of KENT or its ASP, would be defective in operation due to faulty material or workmanship (i.e. manufacturing defects) with the exception of consumables such as Filters.
2. The product's plastic body is not covered under Warranty and hence, it must be handled with care to guard against breakage.
3. The original purchaser of the unit can avail services under Warranty at the point of sale by producing the damaged part(s) along with the original invoice.
4. This Warranty is void if the unit is not operated under normal conditions or according to the instructions given in the manual.
5. Product returned to KENT or its ASP for Warranty examination must be shipped freight prepaid.
6. KENT or its ASP shall not be held liable for claims exceeding the cost of repair of the defects in workmanship.
7. This Warranty Agreement shall not be interpreted to render KENT or its ASP liable for injuries or damages of any kind - direct, consequential or contingent to persons or property.
8. KENT or its ASP shall not be held responsible by representative or buyer for failure to abide by any of the obligations of this Warranty Agreement if such failures are the result of circumstances of Forces Majeures: such as, but not limited to, floods, earthquakes, transportation strikes, labour disputes with outside suppliers or any other conditions beyond the control of KENT or its ASP.
9. KENT or its ASP shall not be held liable for repair or alterations made without prior written approval; for products failures resulting from the lack of proper maintenance.
10. This Warranty Agreement excludes all products/component parts or damage to any part of this Vacuum Cleaner which, in the opinion of KENT or its ASP, have been subjected to misuse; misapplication; negligence; alteration; accident or operation contrary to our instructions, incompatibility with accessories not installed by KENT or its ASP, or that have been repaired with component parts other than those manufactured by or obtained from KENT or its ASP. Damage caused by freezing, flood, fire or Act of God is not covered by this Warranty. In all such cases regular charges will apply. This limited Warranty does not include service to diagnose a claimed malfunction in this unit.
11. KENT reserves the right to alter or improve design and specifications at any time, without any contingent obligations to prospective buyers or owners of the products previously sold.
12. Any disagreements and obligations based upon the purchase of KENT products and thereby imposed on KENT or its ASP shall be governed by and construed according to the laws of INDIA and subject to the jurisdiction of Delhi Courts only.
13. KENT or its ASP assumes no Warranty liability in connection with this Vacuum Cleaner other than that specified herein. This Warranty is in lieu of all other warranties, expressed or implied, including warranties of fitness for a particular purpose. KENT or its ASP does not authorize any person or representative to assume for them any other obligations on the sale of this Vacuum Cleaner.
14. Under no circumstances, the liability of KENT or its ASP shall exceed the value of the product.
15. Under no circumstances are the terms mentioned above negotiable and no employee of KENT or its ASP has the authority to supersede them.

## Important Safety Instructions

When using an electrical appliance, basic precaution should always be followed, including the following:

1. Do not leave vacuum cleaner switched on when plugged in. Unplug, when not in use and before servicing.
2. Use the appliance only as described in the manual.
3. Always use manufacturer's recommended attachments only.
4. Do not use the appliance if the cord or plug is damaged or worn out. Replace the damaged cord or plug immediately.
5. Do not try to service the appliance on your own. Send it to an authorized service center.
6. Never use the cord as a handle, close door on cord, or pull cord around sharp edges or corners. Keep the cord away from heated surfaces.
7. Do not unplug the appliance by pulling the cord. Always unplug by pulling the plug out the cord.
8. To avoid electric shocks, do not use the appliance with wet hands.
9. Keep hair, loose clothing, fingers and all parts of body away from moving parts.
10. Turn off all controls before unplugging.
11. Use extra precaution while cleaning stairs.
12. Do not use the appliance to pick any flammable or combustible liquids, such as gasoline, and also do not use in the areas where they may be present.
13. Unplug before connecting the hose.
14. Do not pick up anything that is burning or leaving smoke, such as cigarettes, matches, or hot ash.
15. Never use the appliance without the filter in place.
16. If the supply cord is damaged, it must be replaced by the manufacturer or a service agent, or a similarly qualified person, in order to avoid a hazard.
17. This appliance is suitable for indoor use only.
18. Keep away from the reach of children.
19. The appliance is not designed to be used by people who are physically or mentally disabled, mentally handicapped or lack the relevant experience and knowledge, unless a person responsible for their safety uses the product with supervision and guidance.

## Troubleshooting

Problem	Possible Cause	Solution Possible
The appliance does not switch on.	<ol style="list-style-type: none"> <li>1. Power Cord not firmly plugged into the socket.</li> <li>2. No power in the main supply.</li> </ol>	<ol style="list-style-type: none"> <li>1. Plug in the unit firmly.</li> <li>2. Check the fuse or cutout switch. Replace fuse or reset the switch.</li> <li>3. Call authorized service center.</li> </ol>
The appliance has weak suction power.	1. Filters are blocked.	<ol style="list-style-type: none"> <li>1. Switch off the cleaner and disconnect the cleaner from the main power supply.</li> <li>2. Remove the filter and clean them.</li> <li>3. Clean the remaining dust inside the dust container.</li> </ol>
	2. Flexible Hose	1. If it is blocked, clean it; If straight tube doesn't connect well, connect it well.
	3. Dust barrel	1. If it is full of water, empty it.
The Flexible hose or brush does not pick any dust.	1. Flexible Hose is choked or there is some blockage in the brush.	<ol style="list-style-type: none"> <li>1. Switch-off the cleaner and disconnect the cleaner from main power supply.</li> <li>2. Remove hose and/or brush and remove any blockage.</li> </ol>

## Technical Specifications

Product	<b>KENT Vortex SS Wet &amp; Dry Vacuum Cleaner</b>
Product Code	116159
Net Weight	3.1 kg
Input Power Supply	Single Phase 220-240 V AC, 50/60 Hz. <input type="checkbox"/>
Max. Vacuum Pressure	> 14 kPa
Airflow	24 L/Sec
Noise (dB)	< 81 dBA
Power Cord Length	4.5 m
Maximum Power	600 W