

KENT *TAP GUARD*

On-Tap Purifier... with UF Membrane

KENT

Tap Guard

On-Tap Purifier

Instruction Manual



Brush your teeth & clean your mouth.



Wash fruits, vegetables & meat.

Now brush, clean your mouth and wash vegetables with bacteria-free, safe water.

Welcome to KENT

Dear Customer,

Congratulations on your purchase and welcome to **KENT** .

At the outset, allow us to thank you for your trust in KENT Appliances. At KENT, we take pride in our reputation for quality products and industry proven performance. We are certain that you will be more than satisfied with KENT Tap Guard's performance and that it will serve you and your family's need without any compromise.

This guide would help you in getting the best out of your appliance. Please go through the booklet to familiarise yourself with its operation and maintenance.

With its robust built quality, you can look forward to years of trouble-free service.

In case you require any further information, please contact your nearest KENT dealer/branch.

Happy Living

KENT RO Systems Ltd.

TABLE OF CONTENTS

- 1. Why Use KENT Tap Guard 1
- 2. Features of KENT Tap Gaurd..... 1
- 3. Items in the Box 1
- 4. Ideal Place for Installation 2
- 5. Know Your Product 2
- 6. Installation Instruction 3
- 7. Using the KENT Tap Gaurd 5
- 8. Important Safety Instructions..... 5
- 9. Tips for Proper Use..... 5
- 10. Precautions 6
- 11. Technical Specifications 6

WHY USE KENT TAP GUARD

We, at KENT have always believed that 'clean and healthy life is a right of every individual'. This ethos is what made us embark on the journey to develop innovative solutions for purifying the water, we drink, vegetables and fruits that we eat, homes that we live in, and the air we breathe.

With use of an innovative technology and supported by a competent service network, we have been able to create a brand which has become synonymous for well-being and health.

Continuing with the tradition, we now present the all-new KENT Tap Guard, to provide you and your family with safe, clean and germ-free water from the tap. The normal water in homes is supplied from overhead tanks. Over a period of time, viruses or bacteria may develop in this water and when this water is used for brushing or cooking, it can make you and your family fall sick. Thus, installing a tap-guard is necessary.

FEATURES OF KENT TAP GUARD

1. Ideal for purifying water from the tap.
2. The Hollow Fiber Ultra Filtration (UF) Membrane filters out bacteria, cysts, etc.
3. Fits on most of the taps.
4. No use of chemicals such as chlorine, bromine or iodine for purification.
5. Food-grade ABS Engineering Plastic construction for trouble-free maintenance and long life.

ITEMS IN THE BOX

1. Valve Body with Attachment Nut : 1 No.
2. Multilayer Hollow Fiber
UF Membrane Cartridge Filter. : 1 No.
3. Adapters : 4 Nos. (2 Nos. with internal thread
and 2 Nos. with external thread)
(Choose one as per your tap)
1 No (with metal clamp for use
with Normal tap)
4. Instruction Manual : 1 No.

IDEAL PLACE FOR INSTALLATION

KENT Tap Guard is ideal for installing in

1. Bathrooms
2. Kitchen Sink
3. Washbasins

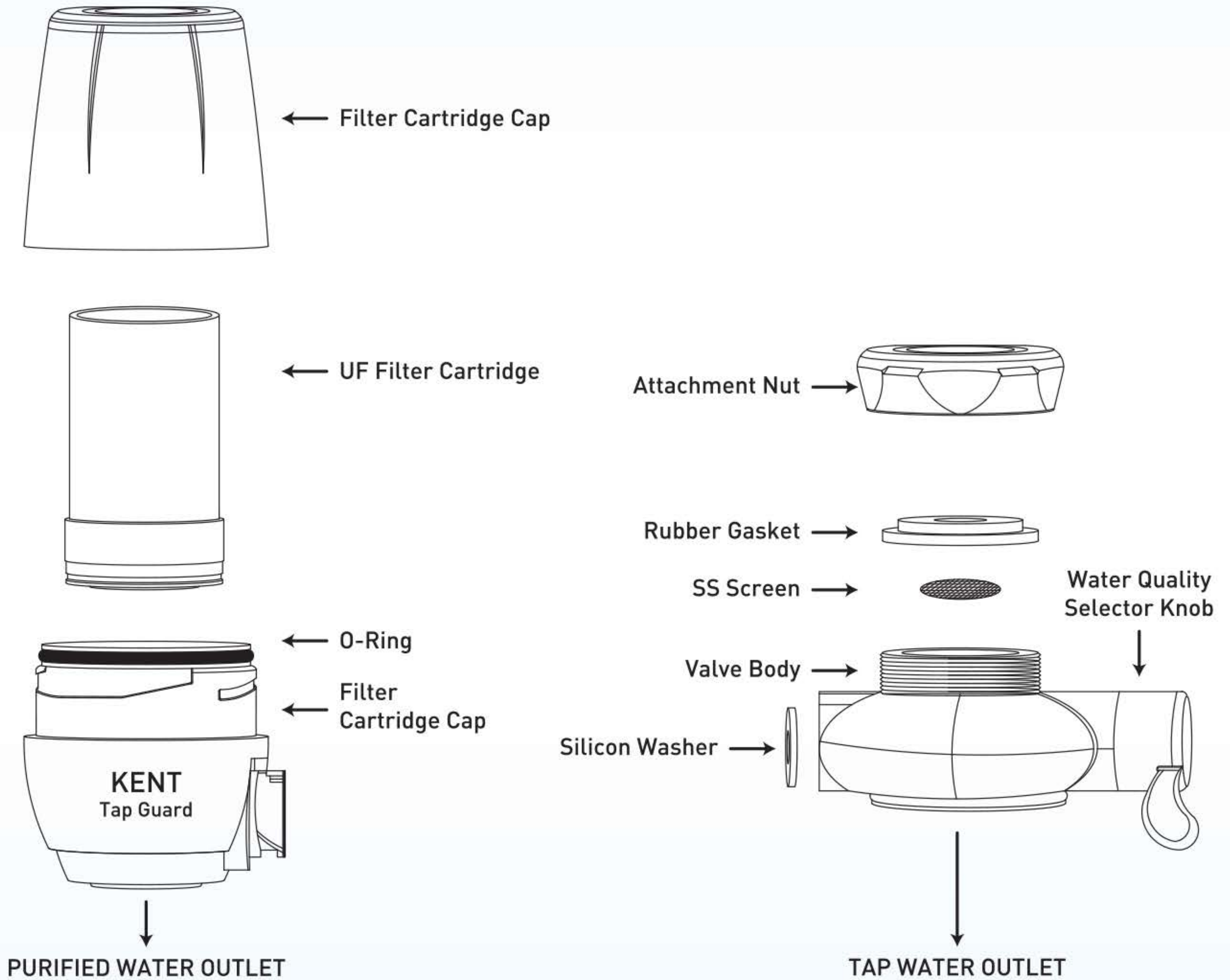

KNOW YOUR PRODUCT



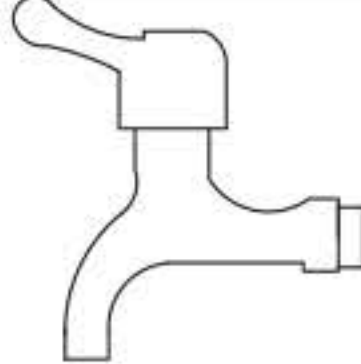
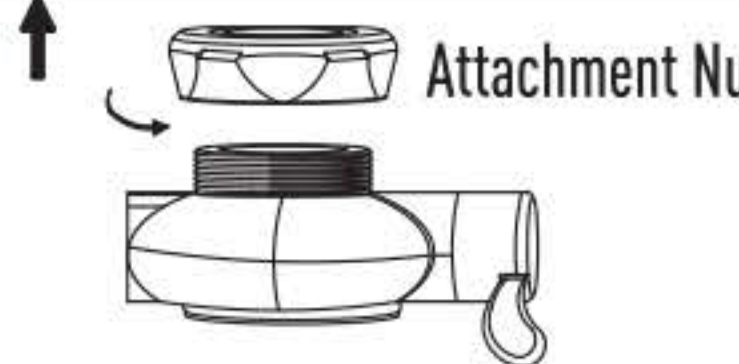

INSTALLATION INSTRUCTION

1. KENT Tap Guard can be connected to three different types of taps that's is
 - a. Normal tap
 - b. Tap with internal threads
 - c. Tap with external threads
2. Determine the type of tap you have from the above mentioned and follow the appropriate steps 1 to 3

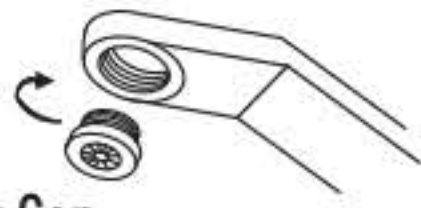
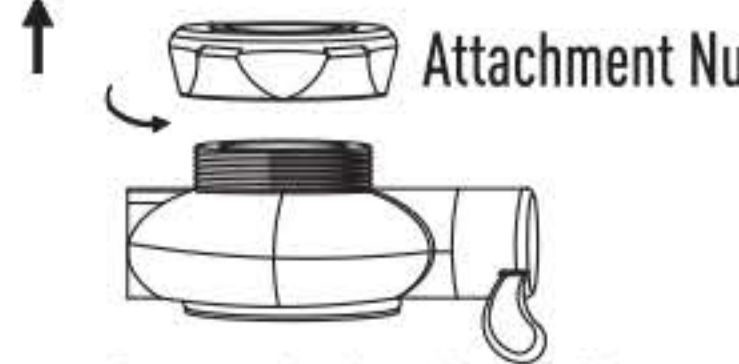

For Normal Tap

	Step 1	Step 2	Step 3
<p>Normal Tap</p> 	 <p>Attachment Nut</p> <p>Remove the Attachment Nut from the Valve Body</p>	 <p>Push the adapter on Tap and fix the metallic holder on adapter Tighten the metallic holder on adapter with the help of screw driver</p>	 <p>Attachment Nut Aerated Nut with internal threads</p> <p>Using the attachment nut tighten the aerator adapter on adapter fitted on Tap with the help of 1 Rs. Coin</p>

For Tap with Internal Thread

	Step 1	Step 2	Step 3
<p>Tap with Internal Threads</p>  <p>Aerator Cap</p> <p>Remove the Aerator Cap from your Tap with the help of 1Rs. Coin</p>	 <p>Attachment Nut</p> <p>Remove the Attachment Nut from the Valve Body</p>	 <p>Attachment Nut Aerated Nut with external threads</p> <p>Using the attachment nut tighten the aerator adapter on adapter fitted on Tap with the help of 1 Rs. Coin</p>	 <p>Now the Tap with attachment nut is ready to tighten Valve body</p>

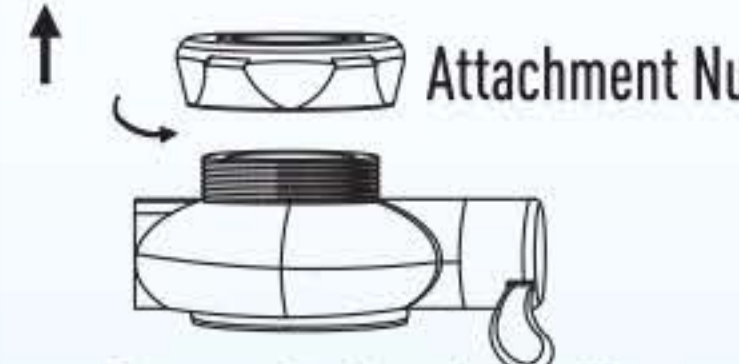
For Tap with External Thread

	Step 1	Step 2	Step 3
<p>Tap with External Threads</p>  <p>Aerator Cap</p> <p>Remove the Aerator Cap from your Tap</p>	 <p>Attachment Nut</p> <p>Remove the Attachment Nut from the Valve Body</p>	 <p>Attachment Nut Aerated Nut with internal threads</p> <p>Using the attachment nut tighten the aerator adapter on adapter fitted on Tap with the help of 1 Rs. Coin</p>	 <p>Now the Tap with attachment nut is ready to tighten Valve body</p>

Step 4 to 9 are common for all types of taps.

Step 4

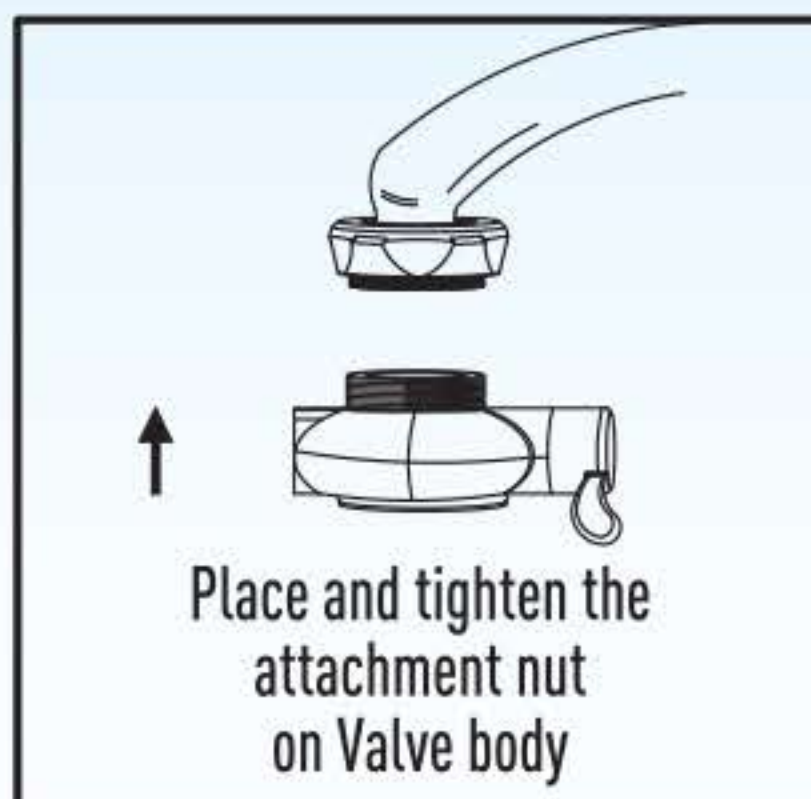

Step 5

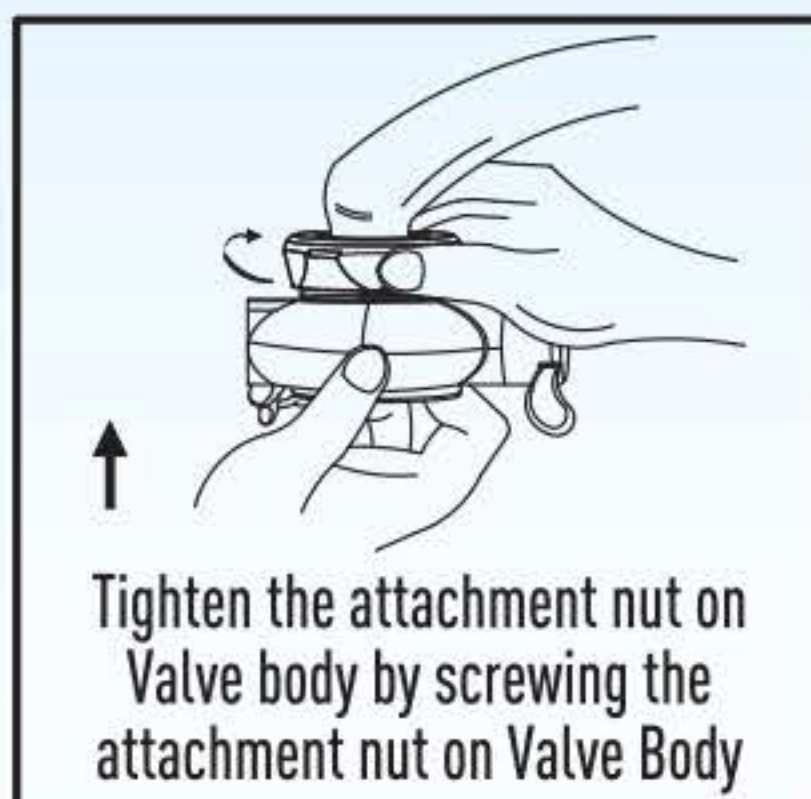

Step 6

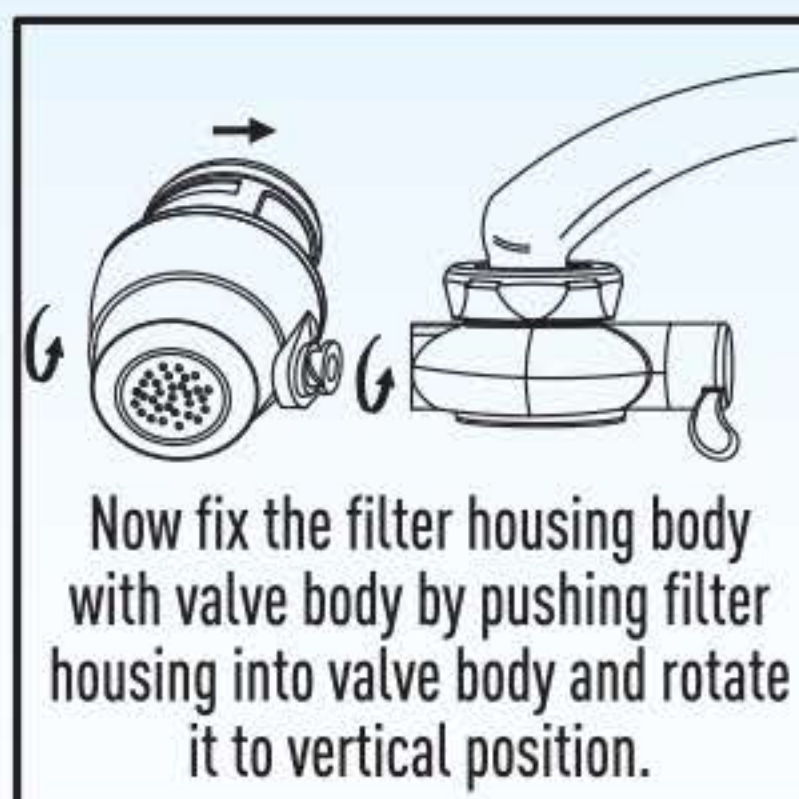

Step 7

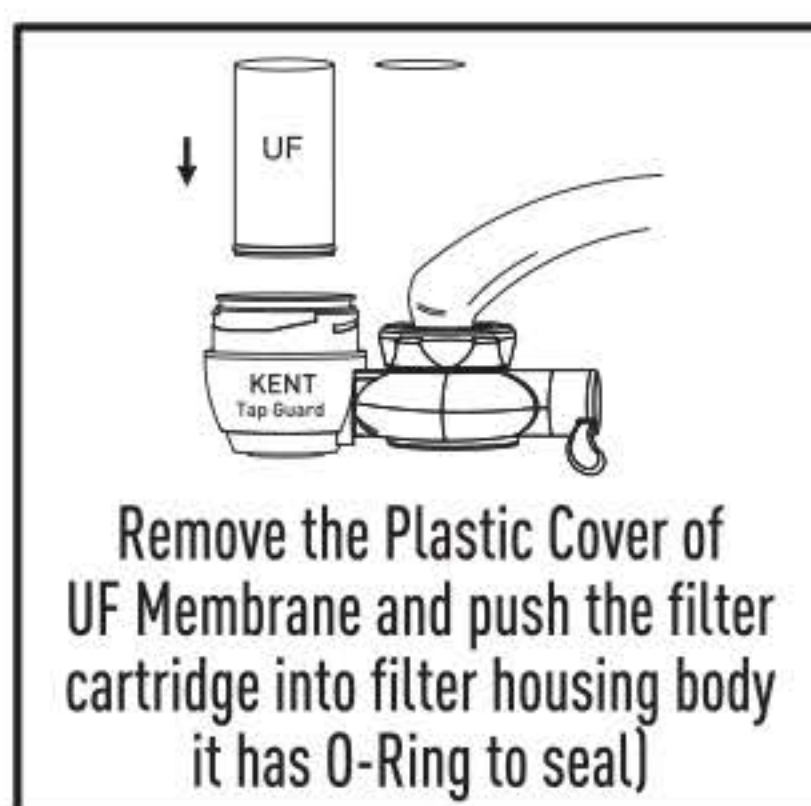

Step 8

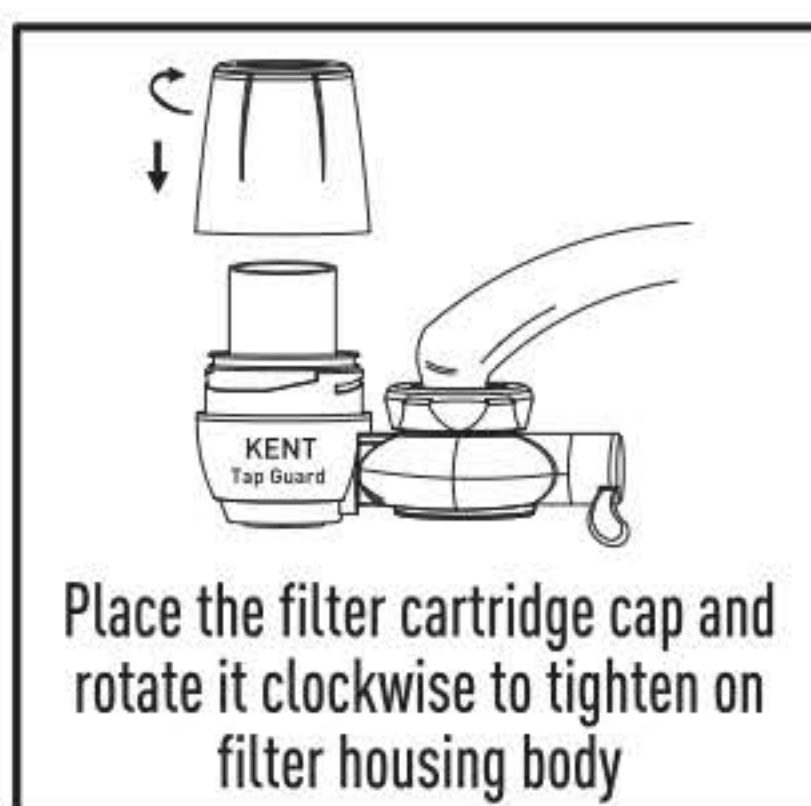

Step 9



USING THE KENT TAP GUARD

1. For Purified water, free from impurities, turn the knob to vertical position as shown in the figure.

Use this setting for brushing, gargling, washing fruits/vegetables and for cooking.

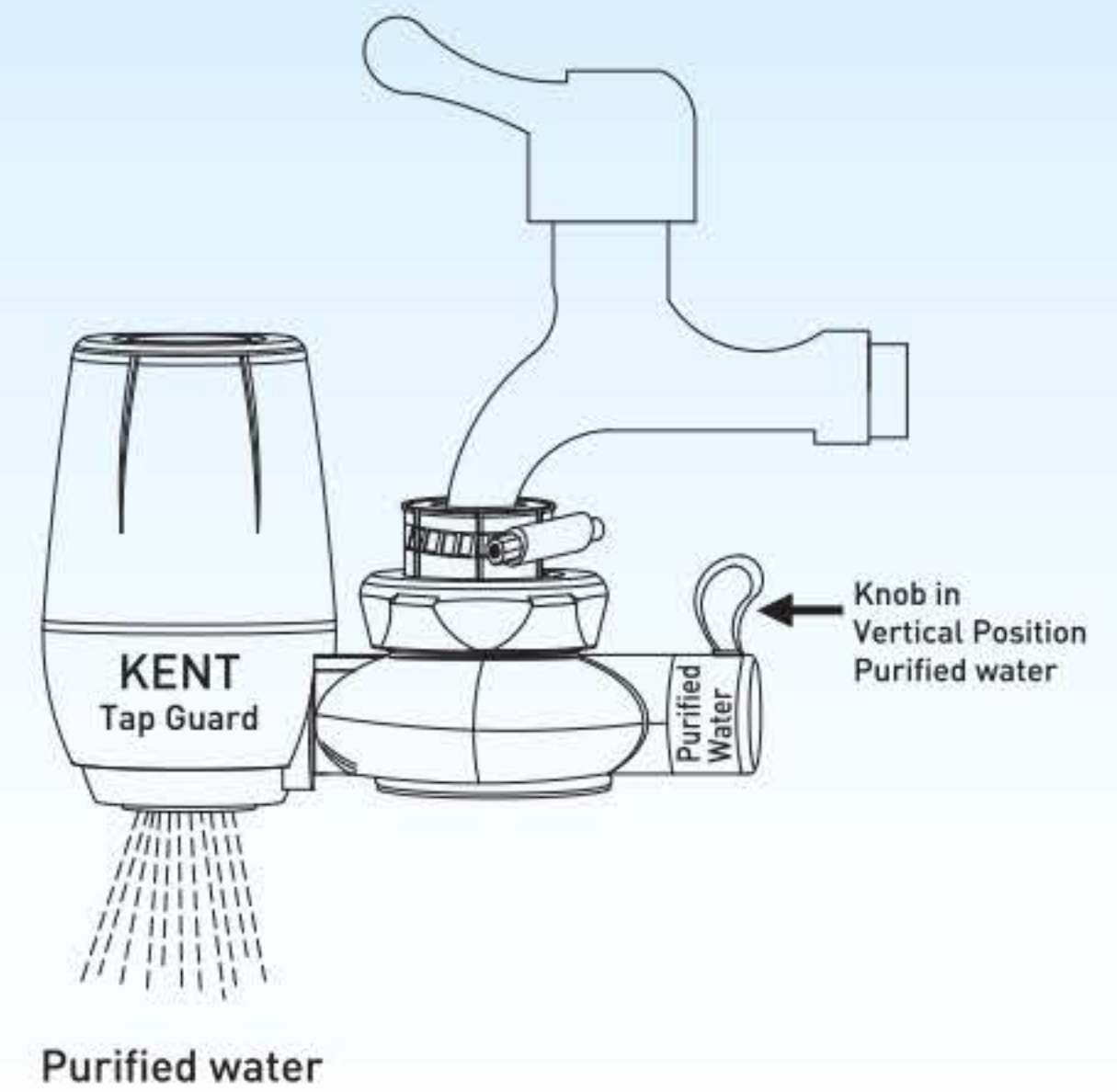

2. For other usage, turn the knob horizontally, as shown in the figure.

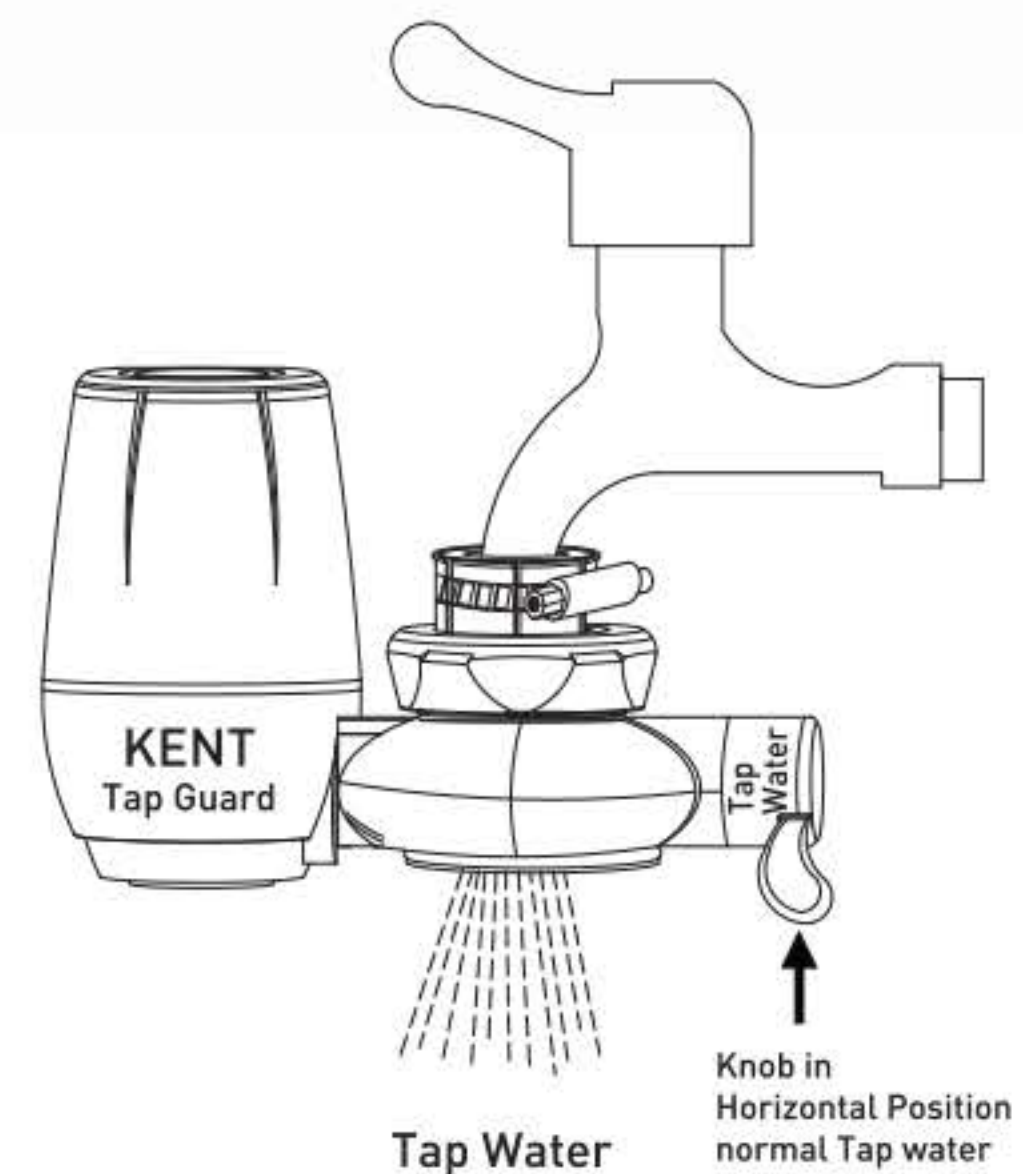

IMPORTANT SAFETY INSTRUCTIONS

1. Please use water which meets drinking water quality standards.
2. Tap Guard does not remove dissolved impurities.

TIPS FOR PROPER USE

1. If the unit is used every day, run water through the filter cartridge for 10 seconds before use, to clean the outlet.
2. If the unit has not been used for 2 days or more, run water through the filter cartridge for 60 seconds before use.
3. If the unit has not been used for 2 weeks or more, we recommend replacing the filter cartridge before reusing, as it may have lost its effectiveness.
4. Keep the purified water outlet clean.
5. The filter cartridges must be replaced every 6 months. Its life span depends on consumed water volume, quality and pressure.

PRECAUTIONS

1. Do not use soap, chemical detergents, thinner or alcohol to clean the unit.
2. Do not use the purifier without a cartridge.
3. Do not remove the cartridge during filtration.
4. Do not run water over 35°C, through the filter cartridge.
5. Do not run water over 50°C, through the unit under any condition.
6. Do not block or attach other objects to the filtered water outlet.
7. Do not allow water to freeze in the unit.
8. Do not use the unit near objects which generate heat.
9. In areas with high water pressure, open the faucet slightly while using the unit.
10. Avoid damage to the faucet and its parts.
11. If the faucet is not tight enough, excessive load may cause water to leak from the faucet attachment, faucet or the plumbing system.

Note: Please remember that damage to spout/spout cap or leaks if any caused by the damage, are not covered under Warranty

TECHNICAL SPECIFICATIONS

Model Name	KENT TAP GUARD
Mounting	On Tap
Net Weight	425 grams
Casing Material	ABS Engineering Plastic
Product Dimension (mm)	145 (L) x 65 (W) x 110 (H)
Operating Water Pressure (Min/Max)	0.1 Mpa to 0.4 Mpa
Operating Temperature (Min/Max)	5° C to 35° C
Filter Material	Hollow Fiber UF Membrane (polysulfide)

KENT
Tap Guard
On-Tap Purifier



Marketed by:

KENT RO SYSTEMS LTD.

E-6, 7 & 8, Sector-59, Noida,

U.P.-201 309, India. Ph.: +91-120-3075000

E-mail: sales@kent.co.in | Website: www.kent.co.in

Manufactured by:

KENT RO SYSTEMS LTD.

Khasra No. 93, Village-Bantakhedi, Tehsil-Roorkee,

District-Haridwar, Uttarakhand-247 668, India.

For customer complaints, contact our Customer Care Officer at:

E-6, 7 & 8, Sector-59, Noida, U.P.-201 309, India.

Call: 092-789-12345

E-mail: service@kent.co.in | visit us at www.kent.co.in